

Spiral SP2

Design by VERNER PANTON

Please read thoroughly before assembly

1

IMPORTANT!

ALWAYS TURN OFF THE ELECTRICAL CURRENT BEFORE INSTALLING ANY FIXTURE!

BE SURE THAT THE CEILING OUTLET BOX IS MOUNTED SO THAT IT CAN CARRY THE WEIGHT OF THE ENTIRE LAMP!

THERE MUST BE NO WEIGHT ON THE ELECTRIC WIRES!

IF THE EXTERNAL FLEXIBLE CABLE OR CORD OF THIS LUMINAIRE IS DAMAGED, IT SHALL BE EXCLUSIVELY REPLACED BY THE MANUFACTURER OR HIS SERVICE AGENT OR A SIMILAR QUALIFIED PERSON IN ORDER TO AVOID A HAZARD.

2

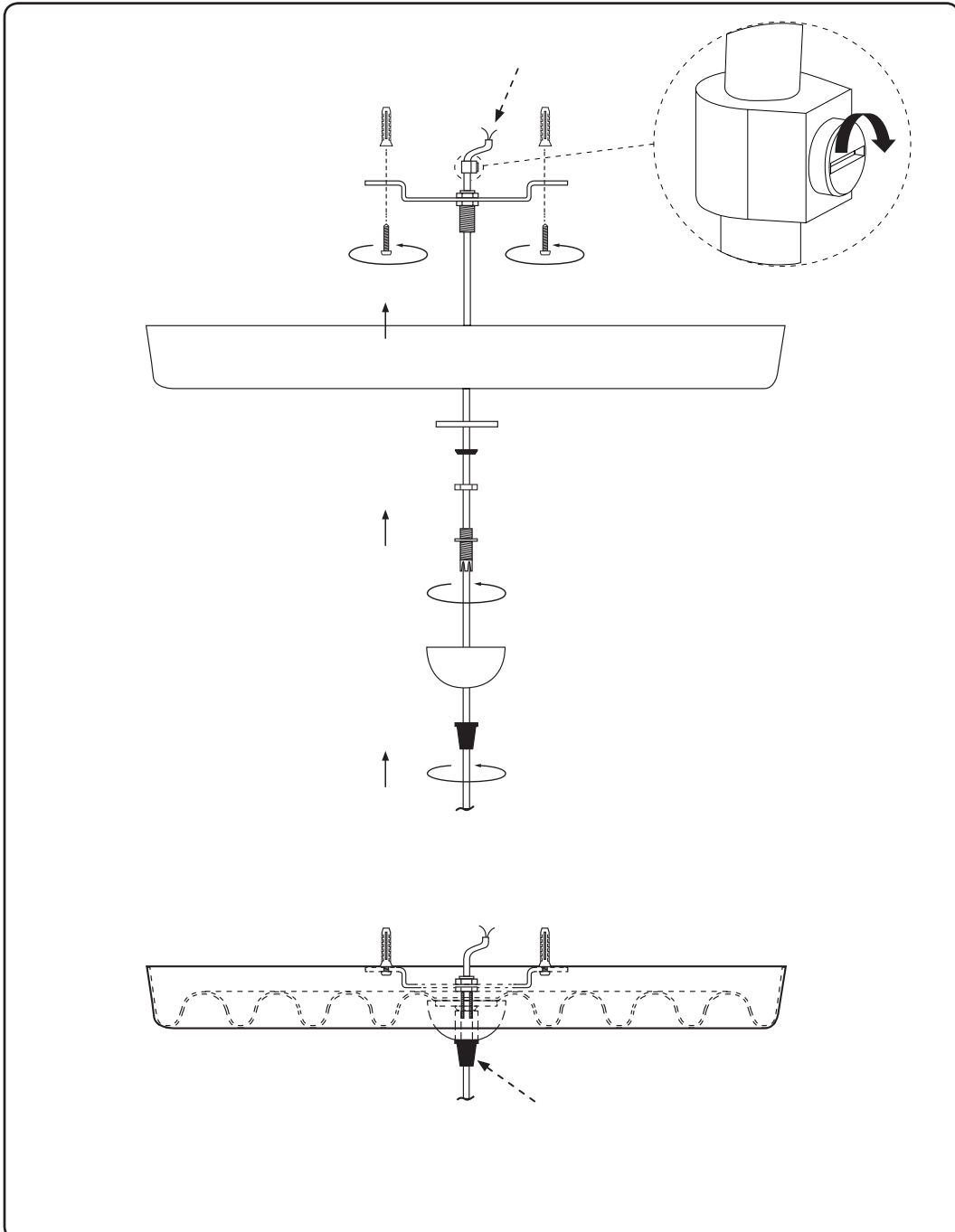

3

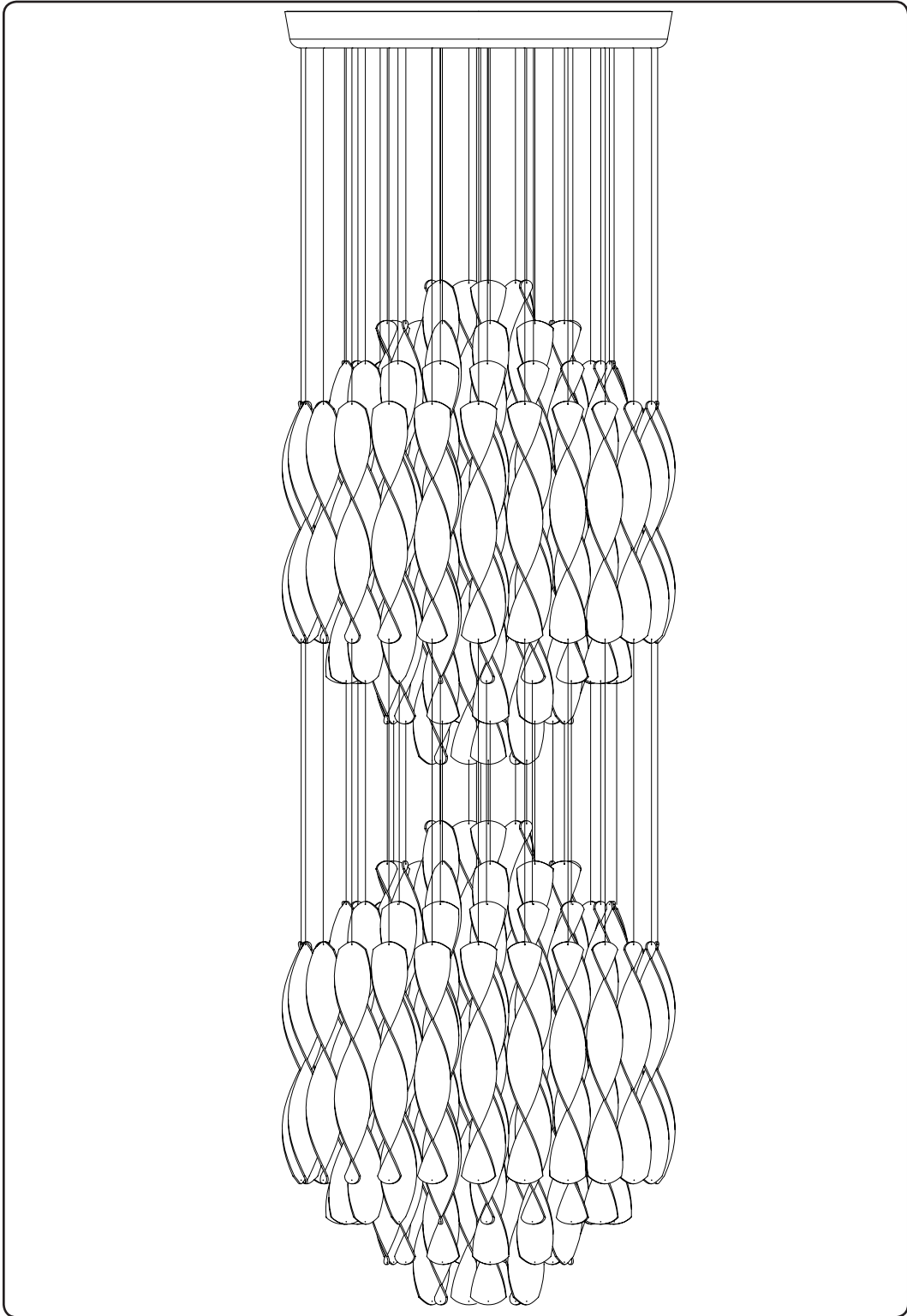

HOW TO CLEAN:

Clean with a soft cloth, warm water and a mild detergent.
Do NOT use any abrasive materials.

DESIGNED
IN THE PAST
MADE FOR
TOMORROW

VERPAN ApS
Egeskovvej 29
8700 Horsens
Denmark

www.verpan.com

info@verpan.com